

Ci4400

Xenon Weather-Ometer[®]



Xenon Weathering

Making the Most Advanced Instruments Even Better

For over 100 years, Atlas instruments have revolutionized the science of weather durability testing. The new Atlas Ci4400 Weather-Ometer® is our most advanced instrument yet - providing easy and effortless operation, unmatched uniformity, increased capacity and a sleeker design, delivering unparalleled value and performance. With its user-friendly touch screen interface and ergonomic features, the best-in-class just got even better.

Simplified Control Navigation

The larger user interface makes operating the Weather-Ometer easier than ever. The Ci4400 delivers exceptionally precise and reliable control of all test parameters for repeatable, reproducible and reliable results.

Commitment to Quality

Producing the very best instruments is not something we take lightly. Every instrument must pass customer specified test parameters. We inspect all xenon lamps and optical filter glass to strict quality specifications. The Ci4400 meets relevant CE, UL, CSA, ISO and EN safety and electrical standards for both machinery and laboratory test equipment.



Sunlight vs. Artificial Light Sources A Comparison of Relative Spectral Power Distribution

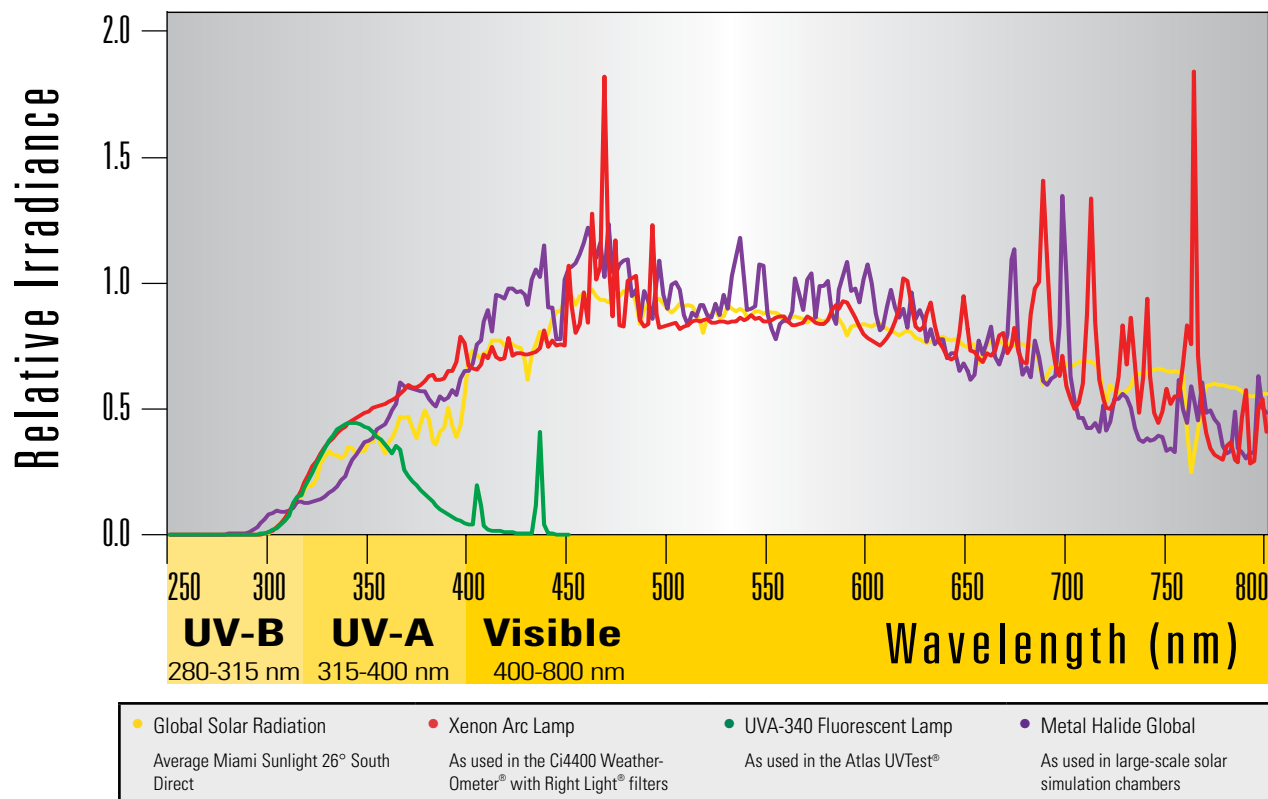

Which Light is Right?

Choosing the “right light” is one of the first steps in creating an accurate and reliable weathering test program. The Ci4400 simulates solar radiation using xenon lamps and advanced filter systems specifically designed for weathering. Atlas xenon lamps meet high performance criteria for their spectral power distribution, lifetime, irradiance stability, and lot-to-lot uniformity.

The Ci4400 uses interchangeable glass filters that tailor the xenon light spectrum to match light conditions in your products’ end use environment.

Controlled Irradiance

The Ci4400 is equipped with the latest in Atlas’ controlled irradiance technology allowing for greater precision and repeatability in weathering testing. Up to 2-sun irradiance levels or higher can be achieved depending on your test requirements. Narrow band (340 nm or 420 nm) or broad band (300-400 nm) irradiance control is available with optional monitoring at a second wavelength to meet global test requirements.

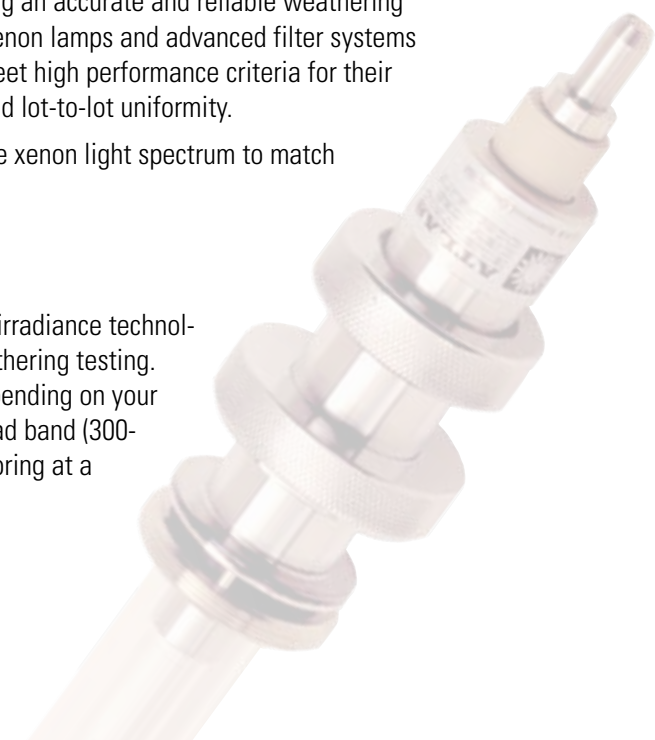

Filter Combinations		Test Conditions	Irradiance Ranges [W/m ²]			
Inner	Outer		Lamp Power	300-400 nm	340 nm	420 nm
Right Light®	Quartz	Weathering tests requiring the most precise match to sunlight available (Meets Daylight filter requirements)	Min Max	32 150	0.32 1.50	0.60 2.75
Right Light	CIRA Coated Quartz	Weathering tests requiring the most precise match to sunlight available and lower test specimen temperatures (Meets Daylight filter requirements)	Min Max	32 150	0.32 1.50	0.60 2.75
Type S Boro	Type S Boro	Most common combination for weathering tests (Meets Daylight filter requirements)	Min Max	26 125	0.23 1.10	0.55 2.57
Type S Boro	Soda Lime	Most common combination for indoor (lightfastness) tests (Meets Window Glass filter requirements)	Min Max	25 120	0.21 1.00	0.55 2.57
Quartz	Type S Boro	Weathering tests with somewhat more and shorter UV than sunlight (Meets Extended UV filter requirements)	Min Max	30 148	0.26 1.21	0.56 2.62
Type S Boro	Soda Lime + Float Glass in Auxiliary Lantern	Common combination for testing European automotive interior trim materials	Min Max	20 99	0.15 0.74	0.53 2.35
Quartz	CIRA on Soda Lime + Float Glass in Auxiliary Lantern	Lightfastness test for automotive interior materials to meet GMW 3414TM	Min Max	N/A	N/A	2.20
Quartz	Type S Boro + 335 nm long pass filter in Auxiliary Lantern	Lightfastness test for automotive interior materials to meet Ford FLTM B0 116-01	Min Max	N/A	N/A	1.06

Features

A Higher Order of Weathering Testing

The new Ci4400 Weather-Ometer[®] performs accelerated material durability testing to a wide range of standards (ASTM, ISO, SAE, etc.). Improvements to the digital control system and new user conveniences combine to create the most easy-to-use laboratory weathering instrument on the market. We've employed new features to allow you to get the most out of your weathering testing as efficiently as possible.

Best-In-Class Uniformity

An improved chamber design provides the best tier-to-tier uniformity of all test parameters

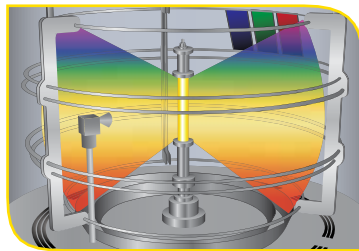

Increased Sample Capacity

The larger rotating specimen rack has over 10% more capacity in the same instrument footprint as the Ci4000



Improved Specimen Rack

The rack has been designed with removable sections for easy sample preparation

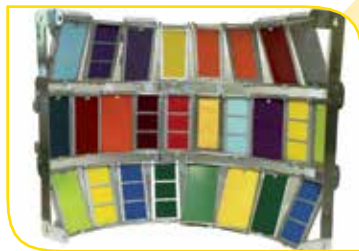

Enhanced DI Cooling System

The newly-designed CS-9 DI cooling system provides safe, efficient, and reliable cooling of your xenon-arc lamp assembly

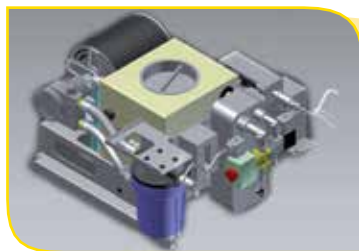

Making Testing Easier

Indicator Light

Easy-to-see test status indicator



Touch Screen User Interface

- Larger touch screen interface
- Several built-in notifications and reminders to aid in instrument uptime and reliability
- Direct setting and control of all test parameters
- Greater use of symbols to optimize screen space for visual output of vital data
- High contrast layout to reduce eye strain



14 Factory Pre-programmed Test Methods

- ISO
- GM
- JASO
- ASTM
- Ford
- AATCC
- SAE

Simplified Setup of Elective Control Features

Set variance level notification for critical variables on one screen

- Irradiance
- Chamber Temperature (CHT)
- Rack Panel Temperature
- Relative Humidity (RH)



Multiple Languages Available

- Chinese
- Czech
- English
- French
- German
- Japanese
- Korean
- Polish
- Russian
- Spanish
- Turkish



Fold-out Tray

Convenient horizontal panel to aid in holding sample racks, logbooks, laptop computers and much more

Functionality & Controls

Irradiance

Rotating Sample Rack

The inclined rotating rack delivers the best exposure uniformity

- Samples are rotated continuously during exposure. No need to manually reposition test samples
- Uniform specimen and chamber temperature, RH, irradiance and spray
- New chamber design allows for even and consistent airflow over sample surfaces

Intelligent Controlled Irradiance (Ci) System

A closed loop system automatically adjusts lamp output in real-time delivering the most stable radiant exposure

- Narrow band (340 nm or 420 nm) or broad band (300-400 nm)
- Irradiance defined by user during test programming or by factory pre-programmed test methods
- Intelligent control allows a user to only select a test method that matches the available wavelength control

New Industrial Design

The Ci4400 design provides greater access into the chamber for xenon lamp assembly mounting, routine maintenance, and cleaning

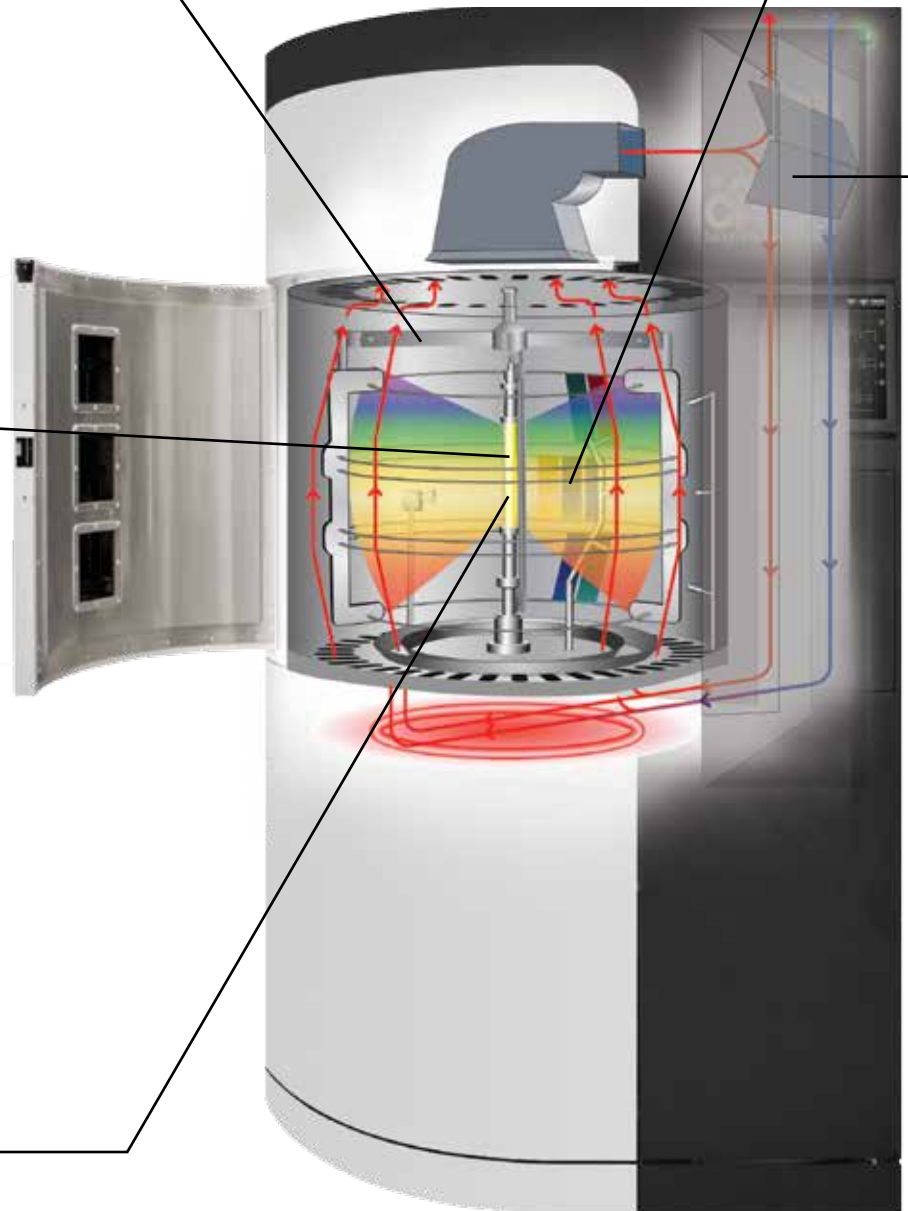

Temperature

Simultaneous Control of BPT/BST and CHT

- Advanced PID algorithms allow for discrete manipulation of rack panel temperature (BPT/BST) and chamber temperature (CHT)
- SmartDamper, variable speed blower, and chamber heater independently control BPT/BST and CHT
- Instrument performance envelope is optimized allowing maximum flexibility in custom test applications



SmartDamper™

- Balances test chamber temperature, BPT, or BST and humidity levels and compensates for changes in ambient laboratory conditions
- Recirculates chamber air, introduces ambient air or a combination of the two

Black Panel Temperature Control Performance

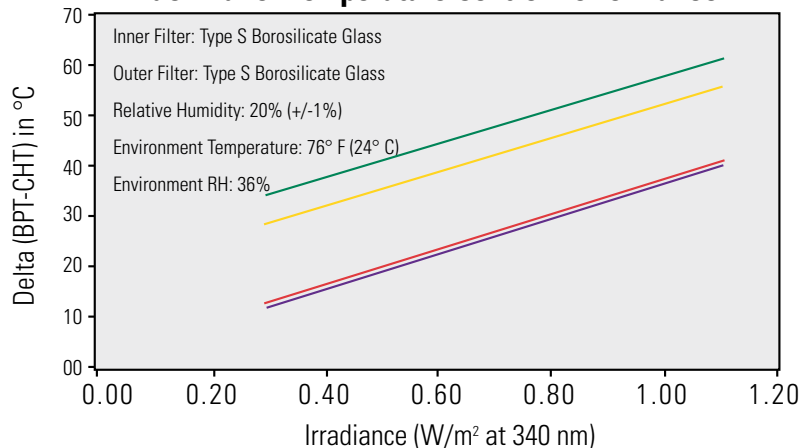

- Minimum Delta BPT/CHT @ 60° C
- Minimum Delta BPT/CHT @ 45° C
- Maximum Delta BPT/CHT @ 45° C
- Maximum Delta BPT/CHT @ 60° C

Moisture

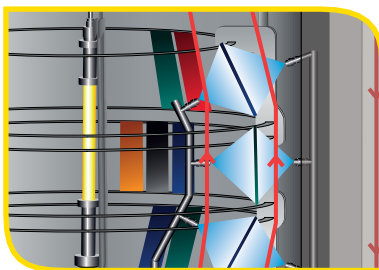

Humidity Control/Specimen and Rack Spray

Direct measurement of relative humidity enables automatic control at the specimen level

- 10% RH to 75% RH in light cycles; Up to 100% in dark cycles*
- Specimen (front) spray simulates rain
- Rack (back) spray in dark phase simulates condensation

* Dependent on other parameters such as lamp power, chamber temperature, ambient lab conditions, etc.

Options

All-In-One Sensor (AIOS)

- Measures irradiance, rack panel temperature, chamber temperature, and relative humidity
- Connects directly to Ci4400 digital control system



- More accurate measurement of conditions at the sample level
- Configurations to meet all common weathering test standards

LiquiAir™ Cooling System

A recirculating DI cooling system that reduces tap water consumption up to 100%*

- Various mounting configurations available, including onboard or wall-mounted options, depending on installation requirements
- A recirculating DI cooling system aiding superior lamp performance

* Dependent on options, ambient lab conditions, and test methods



Auxiliary Filter Lantern

■ For meeting special test requirements:

- ISO 105-B02
- FLTM BO 116-01
- GMW 3414TM



XenoCal® Irradiance Calibration Device

- For independent irradiance calibration and measurement at the sample plane
- Evaluation and graphical display of measured values on a PC by means of the XenoSoft® analytical software
- Available with different wavelength sensitivities:
 - XenoCal NB 340 nm
 - XenoCal BB 300-400 nm
 - XenoCal NB 420 nm

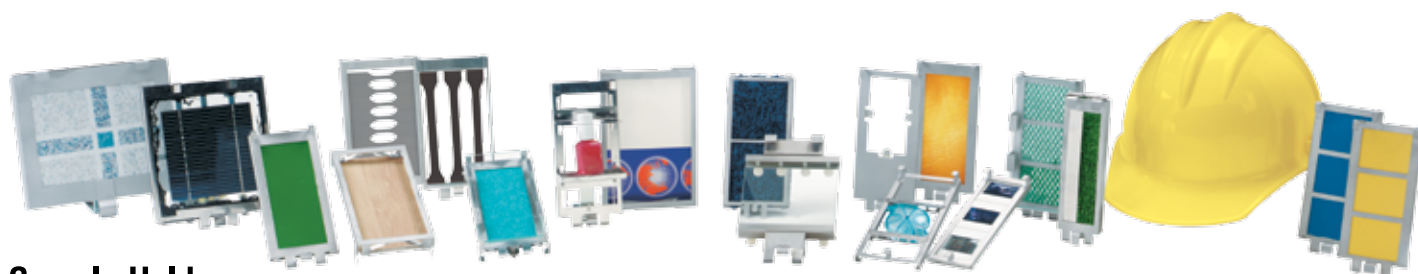

Sample Holders

This chart is a representative sample of specimen holders available for the Ci4400 Weather-Ometer®. For specific information about specimen holders that best meet your needs, please contact your local Atlas representative.

Holder Type (Part Number)	Application	Max Size mm WxHxD	Exposure Size mm WxHxD	Capacity
SL-3T (19163900) Single exposure window with spring clip back	Coatings, textiles, plastics, automotive interior or exterior	67 x 145 x 3	50 x 121	77
RD-3T (20017900) Single or three exposure window with "bulldog" clip	Coatings on various substrates, plastics, textiles, glass	77 x 152 x 10	57 x 134	77
SL-3T with Glass (07303900) Single exposure window with glass and adjustable back	Textiles, paper, plastic film, carpet, automotive interior	67 x 145 x 3	50 x 121	77
CD-3T (20215700) Three exposure windows with spring clip back	Textiles, paper, plastic film, automotive interior	67 x 145 x 3	3 windows: 38 x 50	77
DB-3T (19164800) Single exposure window with two spring clip backs to accommodate both thin and thick specimens	Coatings, textiles, plastics, automotive interior or exterior	67 x 145 x 9	50 x 121	77
TEX-3T with Mask (19186700) Single exposure window with mask, adjustable	Textiles, foam, foam-backed materials	45 x 134 x 12	19 x 119	113
3 x 6 Panel (19188501)	Coatings, rigid plastic, wood	76 x 152 x 9	76 x 146	65
Drop-In Tensile Bar Holder (19184600)	Plastics	77 x 144 x 3	76 x 125	59
WPTC-3T (06150400)	Carpet, foam-backed materials, patterned materials	165 x 146 x 12	131 x 100	30
Textiles for KG1 Test (11500099)	Holder to meet specific requirements of PSA D47 1431	46 x 135 x 12	38 x 125	113
Adjustable Specimen Holder (19210600)	Holds specimens of varying sizes and shapes, including tensile bars and discs	55 x 137 x 5	55 x 127	77
Tensile Bar Holder (19212100)	Holds an 85 mm long tensile bar	85 x 145 x 3	71 x 121	53

Performance

Standard Features

An easy-to-use touch screen user interface that provides:

- Full color 15" display of all test parameters
- Direct setting and control of irradiance: 340 nm, 420 nm or 300-400 nm
- Direct setting and control of BPT/BST
- Direct setting and control of relative humidity
- Direct setting and control of chamber air temperature
- 3-tier inclined specimen rack with removable sections
- CS-9 xenon lamp cooling system
- Test status indicator light
- Fold-out tray to hold sample racks, logbooks, consumables, or laptop computers
- Easy access to chamber for routine maintenance
- Calibrated xenon reference lamp or Xenocal for Ci calibrator
- SmartDamper™ to reduce test variability in chamber temperature and humidity and compensate for changes in ambient lab conditions
- SmartLight™ monitor verifies that correct light capsule is installed
- Streaming data output via Ethernet or USB port. USB thumb drive included
- Display of diagnostic messages
- 14 factory pre-programmed test methods
- Space for 12 custom programs; sub-cycle capability
- Multi-language capability (Chinese, Czech, English, French, German, Japanese, Korean, Polish, Russian, Spanish, Turkish)
- Filter combinations to meet all common test methods
- Chamber viewing window in door
- Specimen and rack spray
- Humidification system
- Water purity indicator with alarm
- Automatic test countdown based on time or radiant exposure
- Universal electrical configurations to meet local frequency, voltage, and electrical requirements
- Designed to meet CE, UL, ISO, EN, and CSA safety requirements
- Air intake dust filter

International Standards

The Ci4400 Weather-Ometer® meets or exceeds the following industry standards:

AATCC	TM 16E	TM 16.3	TM 169					
ASTM	C1442 D3451 D6551	C1501 D4101 D6695	D750 D4303 D7869	D904 D4355 F1164	D1148 D4459 F1515	D1670 D4798 F2366	D2565 D5010 G151	D3424 D5071 G155
Ford	FLTM BO 116-01							
GB/T	1865 16422	3511 16991	6151 32088	8427	8430	10485	14522	16259
GM	GM 9125P	GME 60292	GMW 14162	GMW 14170	GMW 14650	GMW 3414		
Hyundai Motor Co.	MS 210-05	MS 300-32						
IEC	61345							
ISO	105-B02 11341	105-B04 12040	105-B06 16474-1	105-B07 16474-2	105-B10 18909	3917 18930	4892-1 18937	4892-2
JASO	M346	M351						
JIS	B7754	D0205						
MIL STD	810F	810G						
Peugeot/Citroën (PSA)	D27 1389	D47 1431						
Renault	D27 1911	D47 1431						
SAE	J1885	J1960	J2412	J2413	J2527			
VDA	621-429	621-430	75202					
VW	PV 1303	PV 1306	PV 3929	PV 3930				

This is a sample of global standards that can be met by the Ci4400. For more information on additional or specific standards, contact your local Atlas representative. Standards are subject to change without notice. This might lead to the inclusion or exclusion of certain standards.

Specifications

Physical Dimensions

Height	195.2 cm (76.9 in)
Width	104.1 cm (41.0 in)
Depth	171.7 cm (67.6 in)
Floor Space	208.6 cm (82.1 in) x 212.7 cm (83.7 in) Including Access Area
Total Exposure Area	7,200 cm ² (1,116 in ²)

Electrical Specifications

Wiring Connections	3 Phase, 3 Wire w/Ground
Operating Voltage Range	200 - 240 VAC Phase to Phase
Maximum Current	56 A
Frequency	50/60 Hz
Maximum Power	13.8 kW

Wiring Connections	3 Phase, 4 Wire w/Ground
Operating Voltage Range	340 - 415 VAC Phase to Phase
Maximum Current	55 A
Frequency	50/60 Hz
Maximum Power	13.2 kW

Water Requirements

Pressure	DI: 172-276 kPa (25-40 psi) Tap: 138-345 kPa (20-50 psi)	
Flow Rate (max)	Deionized Water	Tap Water @18.5 °C
Humidification	0.4 l/min	N/A
Specimen Spray	0.2 l/min	N/A
Rack Spray	0.2 l/min	N/A
Xenon Lamp Cooling @ 4000 W	N/A	1.5 l/min

Weight

Fully Skidded and Wrapped	735 kg (1620 lbs)
Instrument Alone	669 kg (1475 lbs)

Space Requirements

(Top view with LiquiAir™ option)

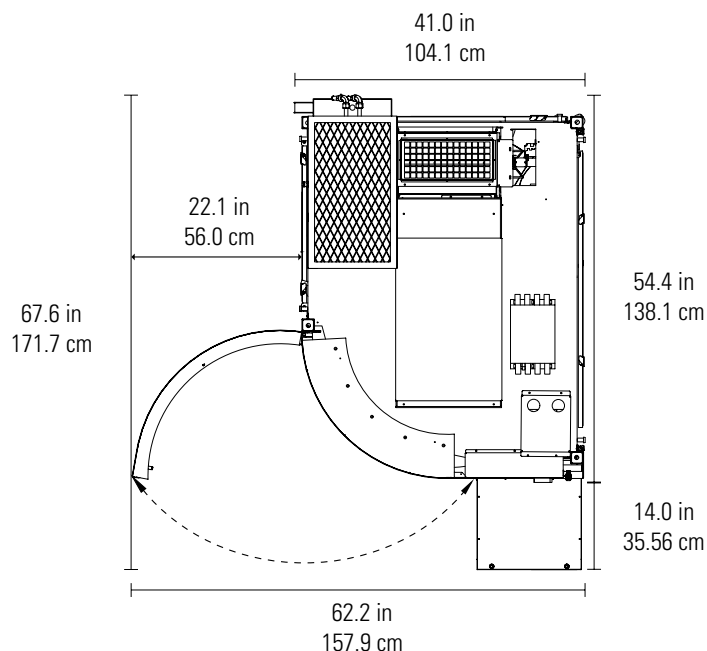

(Front view with LiquiAir™ option)

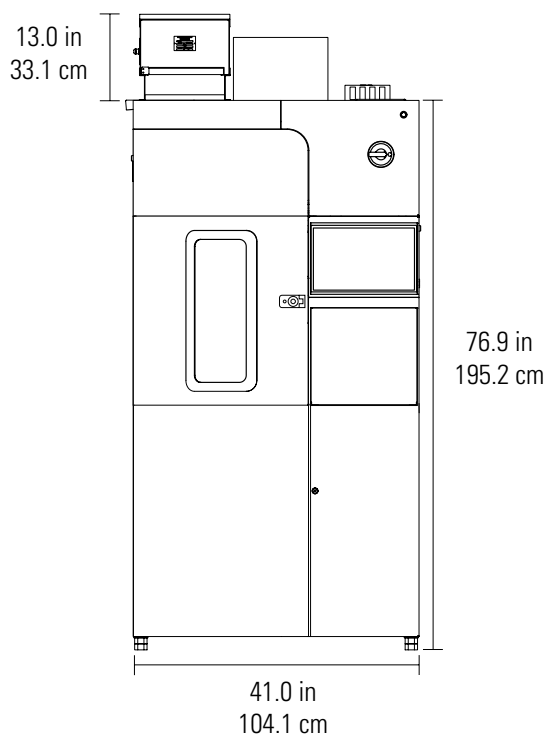

Atlas Worldwide Sales, Services, and Support



■ Corporate Offices

Chicago, Illinois USA ■ Linsengericht, Germany ■ Shanghai, China ■ São Paulo, Brazil
Élancourt, France ■ Mörfelden-Walldorf, Germany ■ Bangalore, India

● Outdoor Exposure Sites & Laboratories

Miami, Florida USA • Phoenix, Arizona USA • Sanary, France • Chicago, Illinois USA • Linsengericht, Germany
Hoek van Holland, The Netherlands • Chennai, India • Prescott, Arizona USA
Loveland, Colorado USA • Medina, Ohio USA • Keys, Florida USA • Jacksonville, Florida USA • Alberta, Michigan USA
Hainan, China • Guangzhou, China • Turpan, China • Seosan, Korea • Miyakojima, Okinawa, Japan
Choshi, Japan • Kirishima, Japan • Singapore • Melbourne, Australia • Townsville, Australia
Novorossiysk, Russia • Gelendzhik, Russia • Moscow, Russia

▲ Local Sales & Service Support

To contact your local Atlas Sales representative please visit <http://atlas-mts.com/contact/local-representatives/>

For general inquiries please contact us at atlas.info@ametek.com